

GEORGE BARNSDALE

Est. 1884

Historic Range



TIMBER WINDOWS & DOORS

 **MADE IN
BRITAIN**

over
130
years
of quality timber
windows & doors

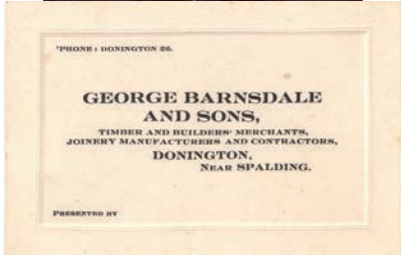

Committed to our heritage

For over 130 years and five generations we have been committed to the manufacture of quality timber windows and doors. We're proud to still remain a family business and to operate from the same site in Donington, Lincolnshire.

- 1884** **George Barnsdale**
The business was started in 1884 when George Barnsdale opened a small carpentry firm, which soon built a reputation on quality craftsmanship.
- 1918** **Walter & Frederick Barnsdale**
Soon after the First World War, George's two sons Walter and Frederick joined the business. It was during this time that the business also diversified into house building, with Walter taking the lead on this as Frederick was a true timber man.
- 1945** **John Barnsdale**
The business did manage to keep trading during the turbulent times of the Second World War but was very much scaled down. After the war, Frederick's son John joined the business and the focus returned solely to timber products.
- 1985** **Helen & Stephen Wright**
When John was at retirement age in 1985, his daughter Helen and her husband Stephen joined the management team. It was Stephen that brought product performance to the forefront.
- 2005** **British Woodworking Federation**
Stephen was President of the BWF for a two year period (2005 to 2007). During this time he contributed to industry regulation and standards.
- 2006** **Tom Wright**
Helen and Stephen's son Tom joined the business in 2006 with the remit to build on performance through the development of the manufacturing process.
- 2014** **SERVOWOOD**
Stephen was invited to contribute to the SERVOWOOD project which is working towards the establishment of European standards for the wood coatings sector.
- 2015** **BWF Historic Committee**
Stephen currently chairs the BWF's Historic Committee which serves to contribute to industry standards and regulation concerning the use of timber in listed properties and conservation areas.

Where time-honoured design and twenty-first century technology meet.

At George Barnsdale we've been crafting the highest quality timber windows and doors at our Lincolnshire-based factory since 1884. We blend detailed design with premium materials and cutting edge technologies to ensure our windows and doors are as enduring as they are beautiful.

One of our key strengths is the sympathetic replacement of timber windows and doors in listed properties and those located in a conservation area. Working closely with planning authorities and conservation officers we have developed the Historic Range to accurately replicate the appearance of original windows and doors, while offering modern performance, long life and low maintenance.

Contents

4 - 5	Exceptional Benefits As Standard	20 - 21	Single and Stable Doors
6 - 7	Sliding Sash Windows	22 - 23	French Doors
8 - 9	Casement Windows	24 - 25	Door Furniture Collections
10 - 11	Yorkshire Sash Windows	26 - 27	Door Configurations
12 - 13	Window Furniture Collections	28 - 29	Glazing Units
14 - 15	Window Configurations	30 - 31	Glazing Finishes
16 - 17	Window Frame, Glazing Bead & Sash Bar Options	32	Timber Options
18 - 19	Entrance Doors	33	Paint and Stain Colours
		34	Our Approach

Exceptional Benefits As Standard

When it comes to the replacement of timber windows and doors in listed properties and those buildings in a conservation area, Conservation Officers are looking for sympathetic replacement to accurately replicate original designs.

We have spent over twenty years developing our Historic Range based upon significant research and testing. The end result is a range of timber windows and doors that adhere strictly to authentic design details and glazing methods whilst providing modern standards of performance, longevity and low maintenance.



Authentic design

To replicate original designs we have incorporated flush joints and solid glazing bars into the design of the Historic Range. Our extensive offering of profiles and layouts, including arched top, internal arch and arch fillet designs allow us to customise our historic timber windows and doors to closely match the original. Plus, our window and door furniture has been carefully selected to mirror original hardware designs.

Enhanced weather performance

With no detriment to the authentic appearance of our historic window and door designs, we have incorporated innovative features to provide excellent protection from the elements. All windows incorporate concealed dual weather seals to help retain warmth and exclude noise and moisture. For the doors, we have integrated concealed gaskets and plugs between the door and the frame to ensure that when the door is closed, the entirety of the frame is completely sealed.

Replication of original glazing

To imitate the reflections given by imperfect crown or cylinder glass, we can incorporate either hand or machine drawn glass into the door or window design. This specialist glass can contribute to the preservation of the original character of the windows and doors. In particular, machine drawn glass works very well with narrow cavity insulated glazing units because it makes it very hard to see that there is a second pane of glass at all.

Improved energy efficiency

For our Historic Range we provide the option of narrow cavity insulated glazing units to replace original single glazing. With slim sightlines, the narrow cavity insulated glazing units provide a compromise between energy efficiency and authenticity and are often favoured in heritage buildings and those properties within a conservation area. Our standard historic glazing incorporates a cavity of 6mm but we can also incorporate units with a 4mm cavity, which is a more costly option.

Enduring quality

Through combining highly-sophisticated machine tooling and hand-finished workmanship we can ensure the highest levels of quality. All of our products are manufactured to the finest tolerances; joints fit perfectly and seals are located with absolute accuracy. Before they leave the factory, each window and door is visually inspected by our skilled craftsmen to ensure that they meet our exacting standards.

Original glazing methods

To accurately replicate the aesthetics and the production methods of the original window, we have developed an external putty glazing system. Utilising modern materials to maximise performance, we are able to provide a five year guarantee against glazing unit failure on all external putted installations.

Long life, low maintenance

When selecting materials our aim is always to achieve exceptional performance while maintaining the most exacting aesthetic standards. Through careful selection of timber and applying the coatings in a humidity controlled factory with precise application by robot, we are confident that our windows and doors will always achieve a long life with low maintenance.

Excellent security

Security is intrinsic to our design approach. Casement windows and doors are fitted with multiple locking points and our historic sliding sash and Yorkshire sash windows incorporate only the highest quality hardware to provide excellent security.

Sliding Sash Windows

Featuring narrow sash rails and thin frames to fit in original openings, our Historic sliding sash window provides an authentic, high quality replacement. All designs offer a high degree of customisation for an accurate match to the original with a number of layouts, horn styles and period window furniture.

High security

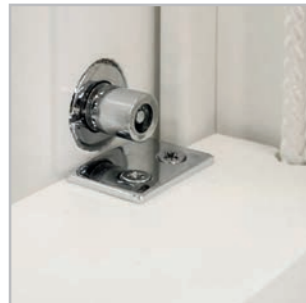

For maximum security, locking sash fasteners are fitted to the meeting rail. The windows are fitted with sash stops on either side of the frame so that whilst they can be opened for ventilation, the opening is restricted for security and safety.

Accurate replication



For an accurate match to the original, top and/or bottom sashes can be specified with traditional sash horns. We offer several different horn types (see page 17), but if required we can match to existing designs.

Excellent weather performance



Our innovative, concealed weather seals achieve a much higher degree of weather performance than most of our competitors' products. Air-tight and discreet they do not detract from the authentic appearance of the window.

Choice of profiles



For single glazing we offer 21mm glazing bars and 24mm for narrow cavity insulated glazing. Both sizes are available in a variety of profiles including pencil round and ovolo (see pages 16 to 17 for an overview of the profiles offered).

Enhanced durability



Frame linings have always been a vulnerable point within sliding sash window designs. To overcome this design issue, and at no detriment to the window's traditional appearance, we only use Accoya® timber linings which provide greater durability.

Design customisation



Our sliding sash windows can be adapted to replicate almost any existing design. We can manufacture them with arched heads, internal arches to the sash, as well as a range of bay and bow window designs (see pages 14 to 15 for our standard layout options).



Historic box sliding sash window finished in a white paint coating and fitted with furniture from The Sash Collection in polished chrome.



Window designs

Traditional box

Based on the original cords and weights design, the traditional box sash window is the most authentic. It provides effortless movement for larger, heavier sashes.

Spiral balance

This window design is traditional in appearance but more modern in operation. Rather than using cords, weights and pulleys to counterbalance the sashes, a concealed spring balance offsets the weight of the sash.

Casement Windows

The Historic flush casement window has been developed to maintain original aesthetics whilst providing enhanced levels of performance. For authenticity, the window incorporates butt hinges, narrow profiles and period matching casement stays.

High security



Rather than trusting the robustness of a single locking point, our casement window design incorporates multiple locking points, including shootbolts. This provides a high degree of security while ensuring a snug, weatherproof fit which contributes to the long life of the windows.

Choice of profiles



For traditional detailing we can incorporate glazing bars. For single glazing we offer 21mm glazing bars and 24mm for narrow cavity insulated glazing. Both sizes are available in a variety of profiles including pencil round and ovolo (see pages 16 to 17 for an overview of the profiles offered).

Excellent weather performance



Concealed dual weather seals contribute to the window's outstanding performance. Discreetly positioned to not detract from the authentic appearance, the weather seals help to retain warmth and exclude noise and moisture.

Design customisation

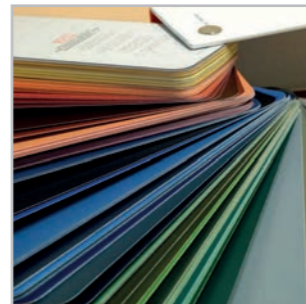

We can provide almost any colour paint or stain finish. If the colour you need to match is not included in our standard options (see page 33), then we can match to a physical sample or to an existing RAL, Natural Colour System or British Standard colour reference.

Authentic design

Traditional butt hinge

Replicating period design, our Historic casement windows incorporate traditional butt hinges. For durability the butt hinges are manufactured in stainless steel and, for an accurate match to the original, they are available in a number of colour finishes.

Casement stays

As standard our side hung casement window designs are fitted with period matching casement stays and handles which operate the multi-point locking. Upon request casement stays can be fitted to top hung casement windows, but this then negates the functionality of multi-point locking.



Historic casement window finished in a white paint coating, incorporating single glazing with a 21mm glazing bar.



Yorkshire Sash Windows

Also commonly referred to as a horizontal sash window, this Historic window design couples a traditional sliding mechanism with advanced draught proofing. A number of configurations are available which are designed to match and complement the existing styles of period properties.

Narrow profiles



As with all windows in our Historic Range, the sashes and frames can be supplied with very narrow profiles allowing them to accurately replicate the appearance of the original windows. This is particularly important on the meeting rail where we are able to supply either a 35mm width for single glazing or a 40mm width for double glazing.

High security



We have carefully selected an elegant and traditional sash furniture collection which provides high levels of security. All windows are fitted with sash fasteners and sash stops, so whilst they can be opened for ventilation, the opening is restricted for security and safety.

Choice of profiles



For single glazing we offer 21mm glazing bars and 24mm for narrow cavity insulated glazing. Both sizes are available in a variety of profiles including pencil round and ovolo (see pages 16 to 17 for an overview of the profiles offered).

Accurate replication



To replicate traditional layout options, we offer a right sliding, left sliding, double sliding and fixed window design (see pages 14 to 15 for our standard layout options).

Excellent weather performance

Traditionally Yorkshire sash windows had very poor weather performance. Through extensive product testing, our historic design incorporates dual weather seals which help to retain warmth and exclude noise and moisture. The weather seals are discreetly positioned to not detract from the authenticity of the window.

Smooth operation

Featuring an innovative track system with concealed rollers, the Yorkshire sash window opens and closes smoothly with minimal effort.



Historic Yorkshire sash window finished in a white paint coating, incorporating narrow cavity insulated glazing with a 24mm glazing bar. Window furniture from The Sash Collection finished in polished brass.



Window Furniture Collections

The look and feel of any window is influenced by the choice of furniture. In the creation of our window furniture collections for the Historic Range we have focussed upon the key elements of authenticity, quality, security and performance.

The Classic Collection

Elegant in appearance with a high quality finish, the Classic Collection has an understated beauty that suits any style of property.

Ball End Handle

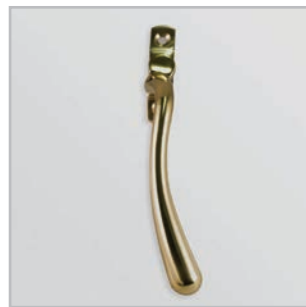

Casement Stay



Finish Options

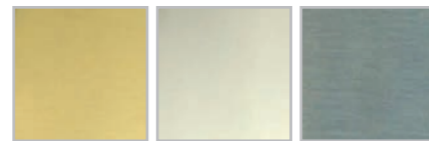

Polished Brass* Polished Chrome Satin Chrome

Shown in polished brass

The Foundry Collection

Offering antique wrought iron handles and casement stays, the Foundry Collection has been designed to provide a rustic appearance that makes it ideally suited to traditional cottages and farmhouses.

Monkey Tail Handle



Monkey Tail Casement Stay



Pear Drop Handle



Pear Drop Casement Stay



Finish Options

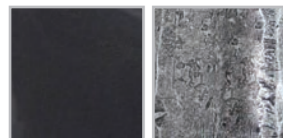

Black Pewter

Shown in black

The Sash Collection

For our sliding sash windows we have an elegant furniture collection that provides simple, effortless operation and high security. The design and finish options allow a perfect match with all of our furniture collections.

Sash Pull



Sash Fastener

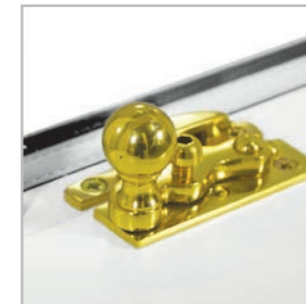

Sash Stop



Sash Eye



Sash Pulley



Finish Options



Polished Brass Polished Chrome Satin Chrome Satin Nickel Antique Brass Bronze Pewter

Shown in polished brass

The Original Collection

The Original Collection features our standard window handles. With simple, ergonomic design and push button locking, the handles are available in a range of colours, allowing seamless integration with a range of buildings and styles.

Original Handle

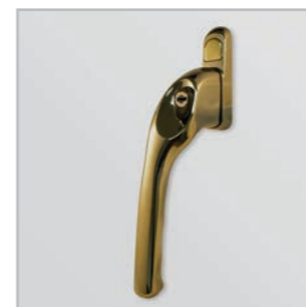

Finish Options



Gold Polished Chrome Satin Chrome White Black

Shown in gold

* Please note, within The Classic Collection the polished brass option is supplied unlacquered on all external furniture for a more durable finish. The unlacquered finish can either be left to take on an antique brass finish or cleaned using a quality metal cleaner to maintain the polished finish.

Window Configurations

To meet the requirements of your project, for each window design we offer a number of opening and layout options. However, if your project demands alternatives we will work with you to develop new variations to meet the brief.

Opening options

Casement

(Shown from outside)

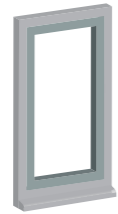

Fixed Sash



Side Hung

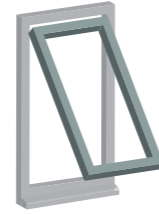

Top Hung

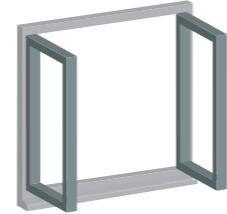

French / False Mullion*

Sliding Sash

(Shown from outside)

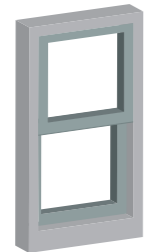

Fixed Sash

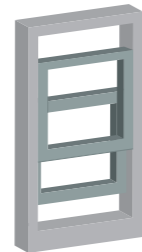

Sliding Sash

Yorkshire Sash

(Shown from outside)

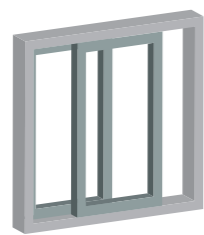

Right Sliding

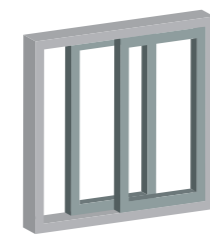

Left Sliding



Double Sliding

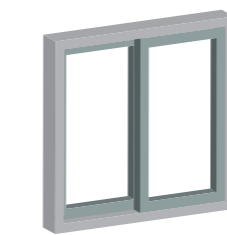

Fixed Sash

Bay & Bow layout options

Casement

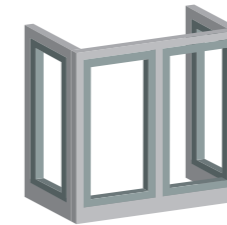

Square Bay

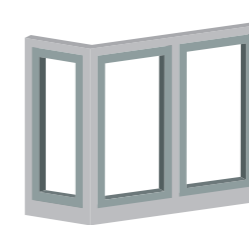

Angled Bay

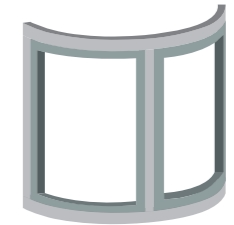

Bow

Sliding Sash

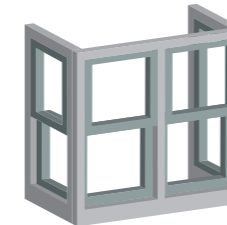

Square Bay

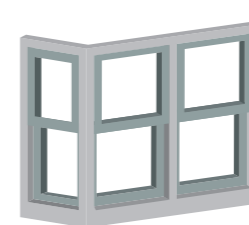

Angled Bay

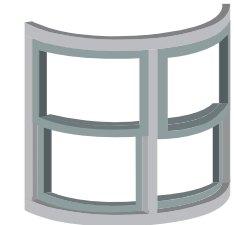

Bow

Round work / Arches options

Casement



Arch Top



Internal Arch

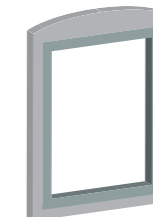

Arch Fillet

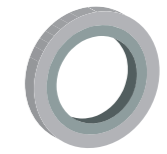

Circular

Sliding Sash



Arch Top



Internal Arch

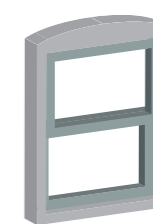

Arch Fillet

*The French option has the two sash rails meeting together, whereas the false mullion option has the frame mullion attached to the second sash to visually replicate a mullion when closed.

Window Frame, Glazing Bead & Sash Bar Options

Casement windows

For outward opening flush casement windows, the following options will need to be specified. Please note, matching sash bead and astragal bar profiles are available.

Internal frame profile

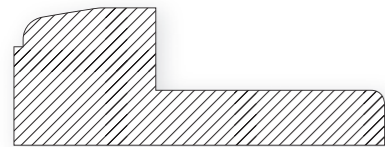

Standard

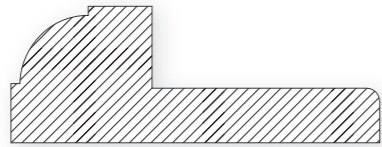

Ovolo

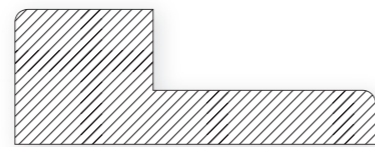

Square

Extended frame profile

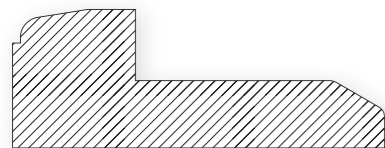

Bevelled Extended

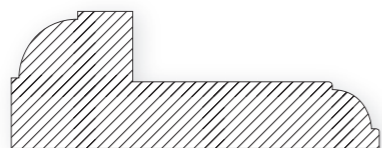

Ovolo Extended

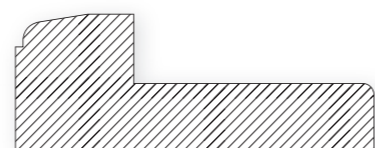

Square Extended

Drips

If your windows are fitted flush with the outside brickwork, we recommend that a head drip is fitted.

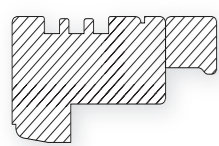

Head Drip

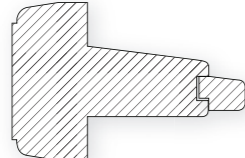

Transom Drip
Type 1

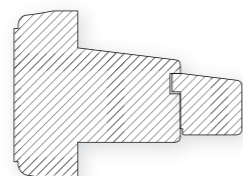

Transom Drip
Type 2

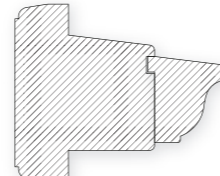

Transom Drip
Type 3

Sliding sash windows

Applicable only to sliding sash windows, top and/or bottom sashes can be specified with traditional sash horns. We offer the following types, but if required we can match existing designs.

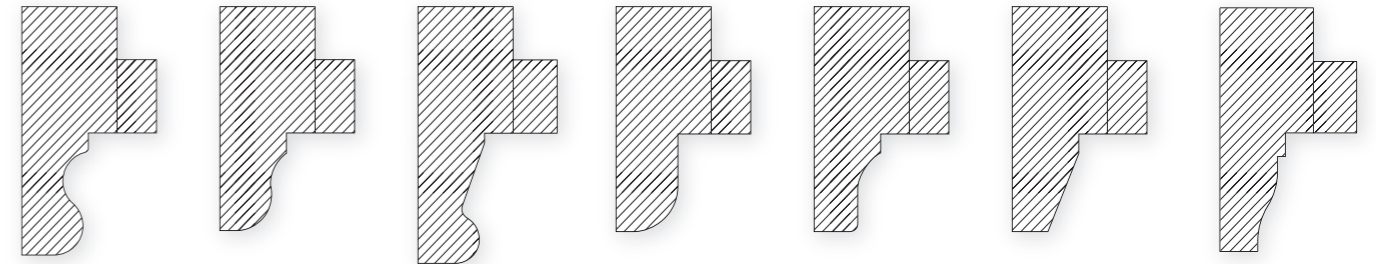

Type A

Type B

Type C

Type D

Type E

Type F

Type G

Sash profiles & glazing bar options

Our externally glazed system has a range of sash profiles and glazing bars, allowing for an accurate match with existing designs.

We have a wide range of sash profiles that allow us to match almost any original glazing system, as shown below. Our standard range uses a 44mm sash, but we have a variety of thicknesses available to suit specific requirements.

The glazing bars are matched with the outside sash profile. A solid glazing bar measures 21mm for single glazing and 24mm for narrow cavity insulated glazing.

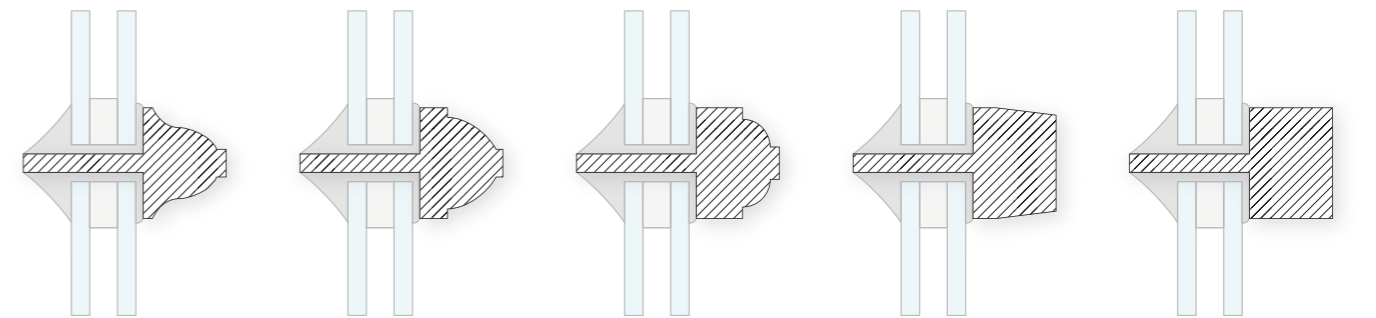

Lambs Tongue

Gothic

Ovolo

Bevelled

Square

Entrance Doors

Based on original period designs our Historic entrance doors couple aesthetic detailing with high security. They are designed to fit flush into the frame and can be supplied as either inward or outward opening.

High security

A property's entrance door is an important aspect of its security. In our Historic entrance door designs we incorporate multi-point locking and the most advanced locks as standard.



Multi-point locking

With a number of locking points distributed along the edge of the door, the multi-point locking system engages all bolts when either the handle is operated or the door is closed (this will depend on the choice of locking system).



Advanced cylinder locks

We only fit cylinder locks that meet the TS007 3 Star British Kitemark and the SS312 Sold Secure diamond standards (the highest rating in both schemes).

Design customisation

To ensure you get an accurate replica of the original, we offer a variety of glazing options, paint and stain finishes and door furniture. Plus, whilst we offer a number of standard designs, we can manufacture to bespoke project requirements.

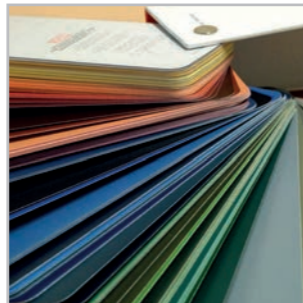

Paint and stain finishes

We can provide almost any colour paint or stain finish. If the colour you need to match is not included in our standard options (see page 33), then we can match to a physical sample or to an existing RAL, Natural Colour System or British Standard colour reference.

Glazing

We offer a number of obscure glass options to help retain privacy, in addition to leaded, colour and stained glass (see pages 30 to 31 for all glazing options).

Door furniture

We offer an extensive collection of period matching door furniture including letter plates, knockers, numbers and spy holes (see pages 24 to 25 to browse our door furniture collections).

Choice of locking systems

Heritage locking system

This is our most authentic locking system featuring a higher lock position and internal thumb turn to replicate a traditional latch. The multi-point locking system engages when the door is closed.

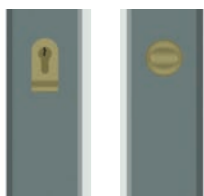

External Internal

Standard locking system

Incorporating handles on both sides of the door which operate the latch and the multi-point locks, our standard locking system has a key operated cylinder to deadlock.

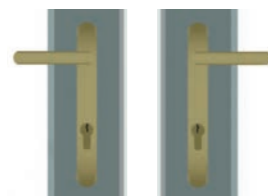

External Internal

Auto-locking system

Similar to the heritage locking system, the multi-point locks are automatically triggered when the door is closed. Only one handle is incorporated and this is located on the internal facing side.



External Internal



Entrance door incorporating historic narrow cavity glazing, finished in a Signal Red (RAL 3001) paint coating with door furniture in polished brass.



See pages 30 to 31 to view all glass options.

Single and Stable Doors

We have adapted the single and stable door designs from our Traditional Range to suit properties of historical significance. Our Historic single and stable doors are a perfect addition to the side and rear of period properties, with the stable-door design especially suited to cottages and farmhouses.

High security

Our door designs match period authenticity with high levels of security, incorporating multi-point locking and the most advanced cylinder locks as standard.



Multi-point locking

With a number of locking points distributed along the edge of the door, the multi-point locking system engages all bolts when either the handle is operated or the door is closed (this will depend on the choice of locking system).



Advanced cylinder locks

We only fit cylinder locks that meet the TS007 3 Star British Kitemark and the SS312 Sold Secure diamond standards (the highest rating in both schemes).

Design customisation

For an accurate match to the original we offer high levels of customisation through a variety of glazing, paint and stain finishes. We can also manufacture to bespoke project requirements.

Glazing bars

For traditional detailing we can incorporate glazing bars. For single glazing we offer 21mm glazing bars and 24mm for narrow cavity insulated glazing. Both sizes are available in a variety of profiles including pencil round and ovolo.

Paint and stain finishes

We can provide almost any colour paint or stain finish. If the colour you need to match is not included in our standard options (see page 33), then we can match to a physical sample or to an existing RAL, Natural Colour System or British Standard colour reference.

Glazing

We offer a number of obscure glass options to help retain privacy, in addition to etched and stained glass (see pages 30 to 31 for all glazing options).

Choice of locking systems

Single doors

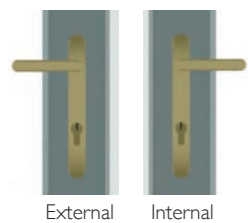

Standard locking system

Incorporating a handle on both sides, this system is most suitable for those doors that do not open onto a public space. It has a key operated cylinder to deadlock.

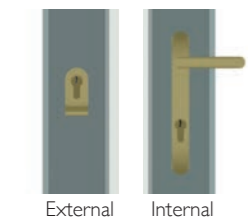

Auto-locking system

With only one handle located on the internal facing side, the multi-point locks are automatically triggered when the door is closed. This makes it the ideal choice for those doors that open onto a public or communal area.

Stable doors



For the stable door, the top door is operated in the same way as our standard locking system with a handle on each side. The lower door has a cylinder operated by a key externally and a thumb turn internally.



Single door incorporating historic narrow cavity glazing, finished in a white paint coating with door furniture from The Foundry Collection in black.



See pages 30 to 31 to view all glass options.

French Doors

Replicating the aesthetics of a traditional French doorset, our Historic designs are available as both inward and outward opening. High levels of customisation can be achieved with a large choice of paint and stain colours, glazing and door furniture.

High security

Similar to the Historic entrance, single and stable door designs, all French doorsets incorporate multi-point locking and the most advanced cylinder locks.



Multi-point locking

Concealed multi-point locks with integrated shootbolts in the slave door provide security as well as support along the length of the door to help prevent movement.



Advanced cylinder locks

We only fit cylinder locks that meet the TS007 3 Star British Kitemark and the SS312 Sold Secure Diamond standards (the highest rating in both schemes).

Excellent weather performance



When the master and slave doors are closed, the concealed gaskets and sealing plugs between the door and the frame ensure that the entirety of the frame is completely sealed. This provides excellent performance against the elements at no detriment to period authenticity.

Adjustable for perfect operation



Our designs incorporate both adjustable hinges and keeps which allow both doors to be set after insulation. This helps to maintain the perfect balance between ease of closing and tight weather sealing.

Concealed restrictor



To help prevent damage from the door being blown in the wind, all outward opening French doorsets are fitted with a restrictor to limit opening to 90°.

Easy to operate

To replicate the aesthetics of traditional French doors, as standard our Historic French doorset features a one handle locking system. It is simple to operate with the master door operated by a handle and the slave door incorporating shootbolts, both top and bottom, which are operated by a concealed lever that is accessible when the master door opens.

Upon request, we can also incorporate a two handle locking system. In line with more modern French doorsets, the master door locks into the slave door, with the slave door having both top and bottom shootbolts which are operated by a handle.



Historic French door featuring narrow cavity glazing, finished in a white paint coating with polished brass door furniture.



Door Furniture Collections

To ensure that you get a consistent finish across all products, our door furniture collections mirror those that we offer for our windows. In their creation we have focussed upon the key elements of authenticity, quality, security and performance.

The Classic Collection

Elegant in appearance with a high quality finish, the Classic Collection has an understated beauty that suits any style of property.

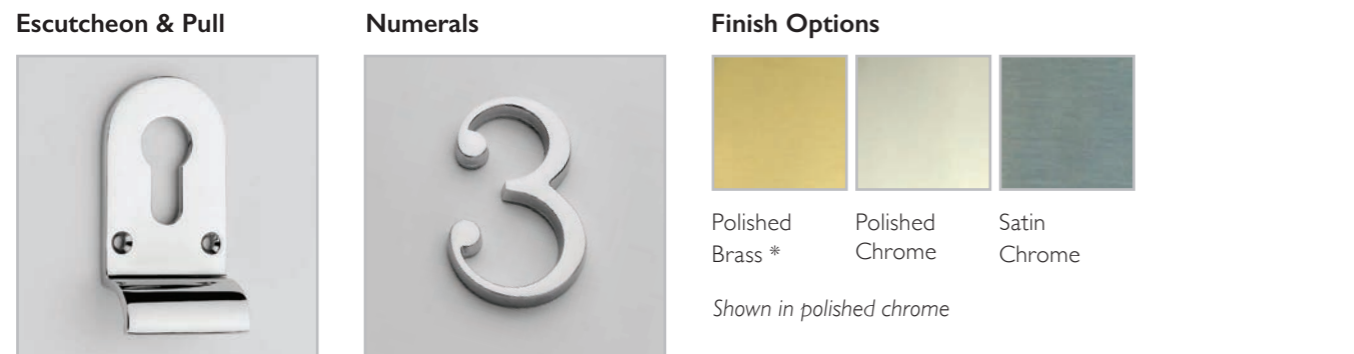
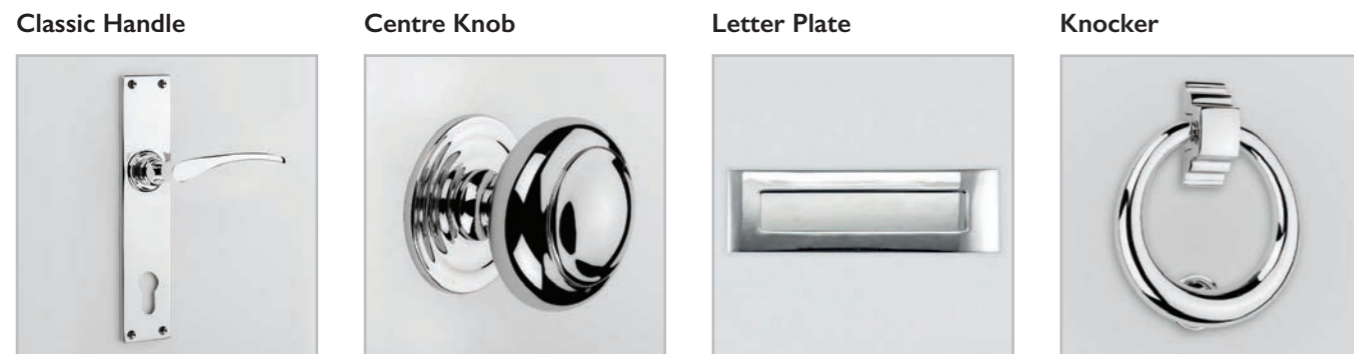

We offer all numerals.

*Please note, within The Classic Collection the polished brass option is supplied unlacquered on all external furniture for a more durable finish. The unlacquered finish can either be left to take on an antique brass finish or cleaned using a quality metal cleaner to maintain the polished finish.

The Foundry Collection

Manufactured using traditional wrought iron methods, the Foundry Collection provides a rustic appearance that makes it ideally suited to cottages and farmhouses.

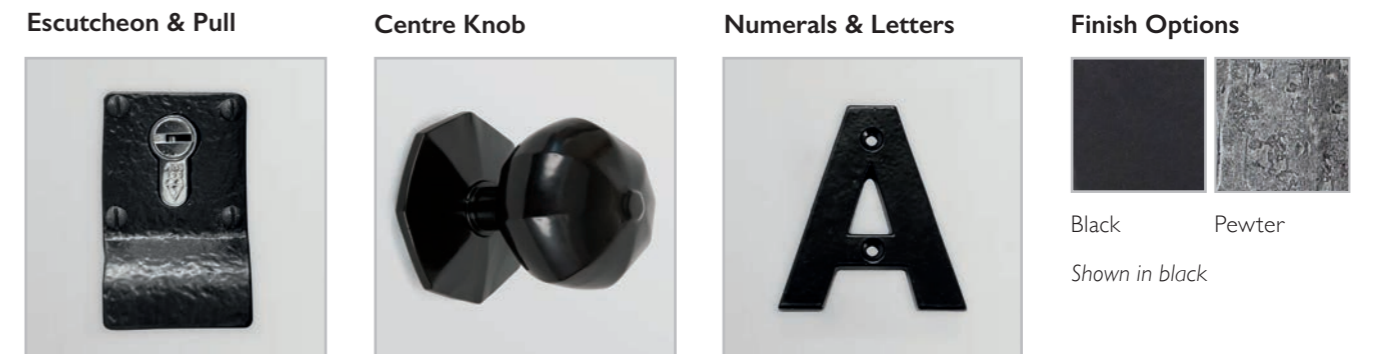
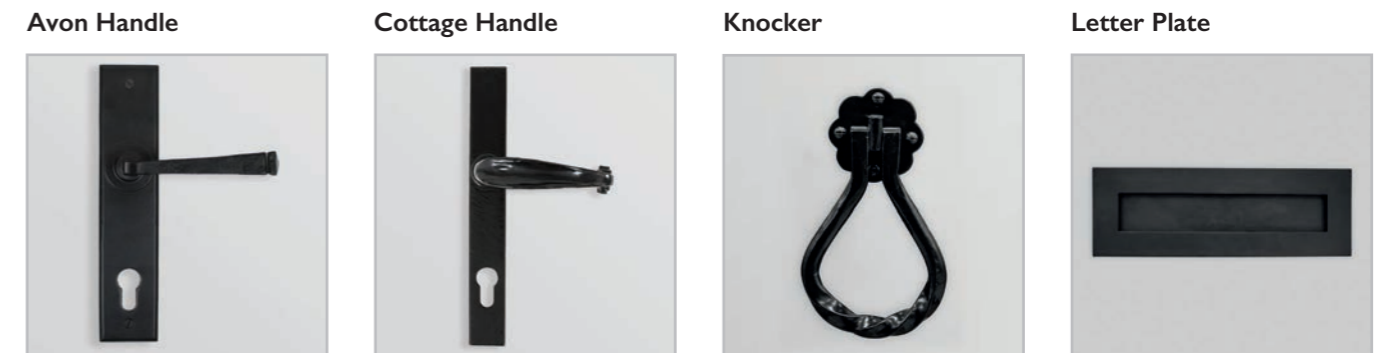

We offer the entire alphabet and all numerals.

The Original Collection

This is our standard door furniture collection which has been designed to allow seamless integration with a range of buildings and styles.

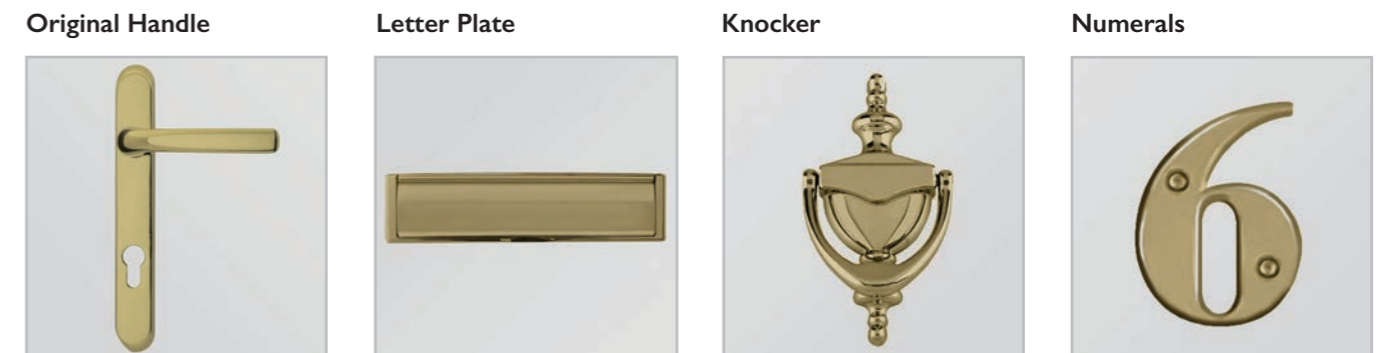

Knocker also available with integrated spy hole.

We offer all numerals

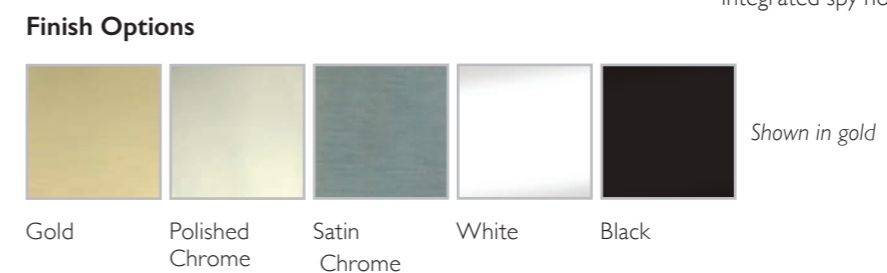

Door Configurations

We have a number of door styles and configurations as standard, which are summarised below. These standard door designs are provided as a guide to provide inspiration. In reality, we can manufacture to any design specification, meaning that we can meet any bespoke needs.

Door style options

Entrance doors

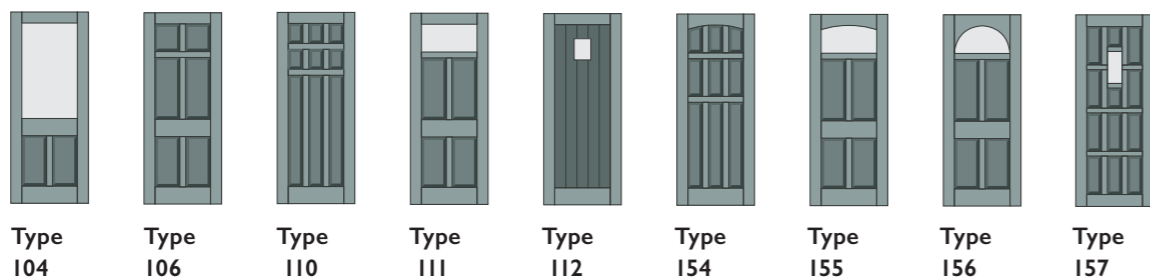

Single doors

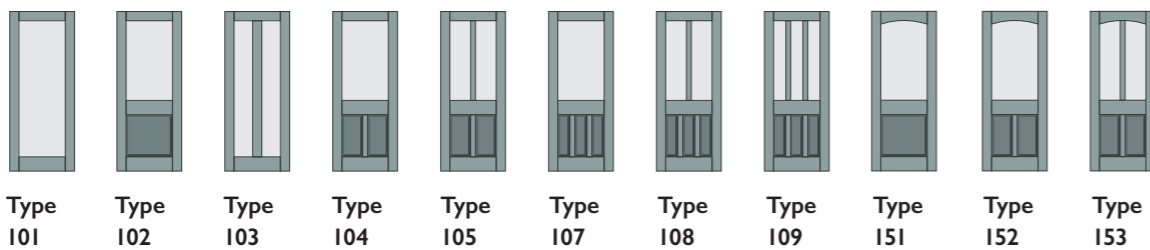

Stable doors

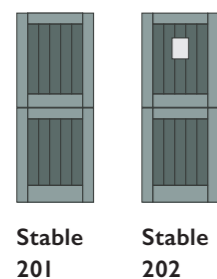

French doors

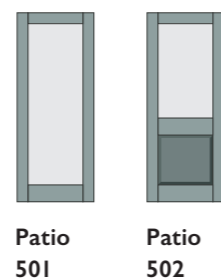

Doorset layout options

Entrance doors



French doors

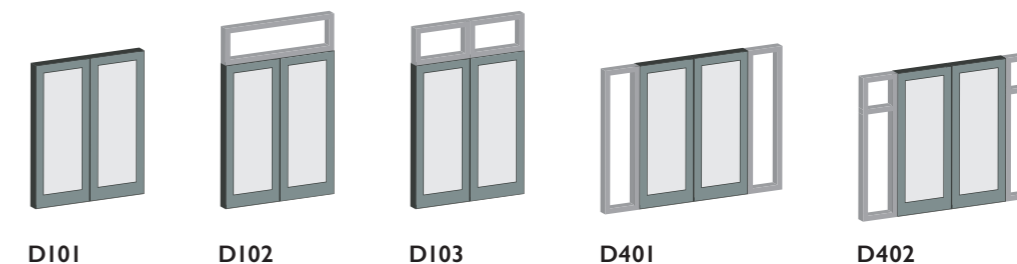

Glazing Units

Due to historic timber windows and doors featuring narrow sashes and sightlines, the specification of double-glazed units becomes more complicated.

Over recent years, narrow cavity insulated glazing has been developed to overcome these challenges. Commonly referred to as slim double-glazing, narrow cavity insulated glazing has a smaller cavity compared to conventional double-glazing which results in a smaller overall thickness. With a narrower cavity, there is the requirement of specific gases to provide thermal insulation and advanced edge seals to space and seal the gas.

Glazing unit options

Working with leading glazing suppliers we offer three types of glazing, all of which have proven test data to ensure that they meet our exacting performance requirements. The glazing option that you choose will depend upon conservation planning requirements, your own personal preference and the allocated budget. The types of glazing units that we offer are summarised below:

Historic narrow cavity glazing unit

This is our standard narrow cavity insulated glazing option. With a cavity of 6mm, this unit incorporates a warm edge spacer bar and Krypton gas to provide good thermal insulation. Glazing finishes offered with this unit are as follows:

- Hand drawn glass
- Machine drawn glass
- Decorative glass
- Acoustic glass
- Thermal laminates
- Obscure glass

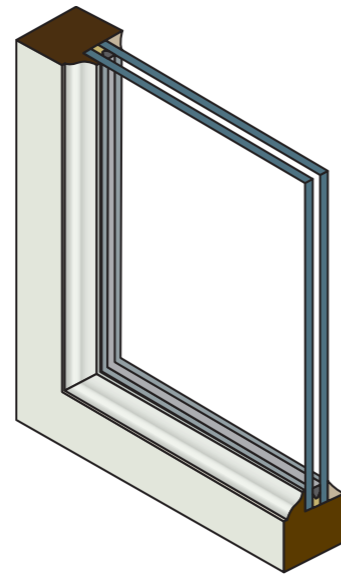

Glazing Style	Safety Type	Thermal		Acoustic	Delivery	Price
		U glass	U window	Rw		
Barnsdale Historic	Toughened or Laminated	1.2 – 2.1	1.5 – 2.1	31-35	Standard	£££

Single glazing unit

We offer single glazing in a range of thicknesses. Glazing finishes offered with this unit are as follows:

- Hand drawn glass
- Machine drawn glass
- Decorative glass
- Acoustic glass
- Thermal laminates
- Obscure glass

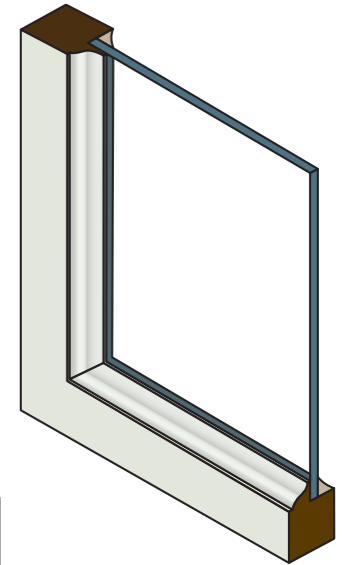

Glazing Style	Safety Type	Thermal		Acoustic	Delivery	Price
		U glass	U window	Rw		
Single Glazed	Toughened or Laminated	5.7	4.5	29	Standard	£

Pilkington Spacia (vacuum glass) unit

By creating a vacuum between the two panes, this glass is the best performing and also the narrowest with a 0.2mm cavity. The use of this glass allows most products to meet the thermal performance criteria outlined in the Building Regulations. In order to achieve a vacuum, the glass uses micro spacers within the unit and has a plug in the corner (the point where the air is extracted). Whilst the plug is discreetly positioned, it is visible when stood within a few metres of the window.

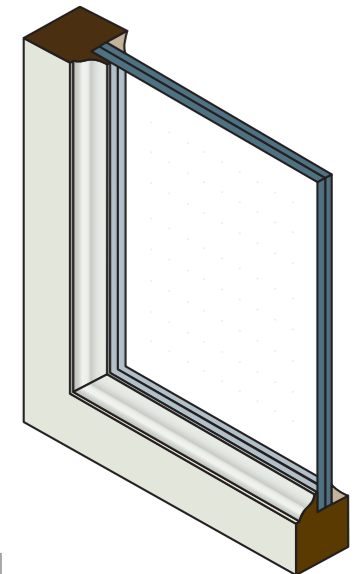

Glazing Style	Safety Type	Thermal		Acoustic	Delivery	Price
		U glass	U window	Rw		
Pilkington Spacia	Safety Film	1.1	1.6	34	+ 6 weeks	££££

Glazing Finishes

Hand and machine drawn glass

To address the challenges brought by replacing the original glass, all of our glazing units can incorporate hand or machine drawn glass. These types of glass mimic the reflections and irregularities given by imperfect crown or cylinder glass which can occasionally be a prerequisite of planning.

We would always recommend discussing glass requirements with your local planning or Conservation Officer first. In our experience modern float glass is acceptable in the majority of cases, and is a much more cost effective option as long as the replacement window design matches the original as accurately as possible. The below images show the differences between hand drawn, machine drawn and float glass:

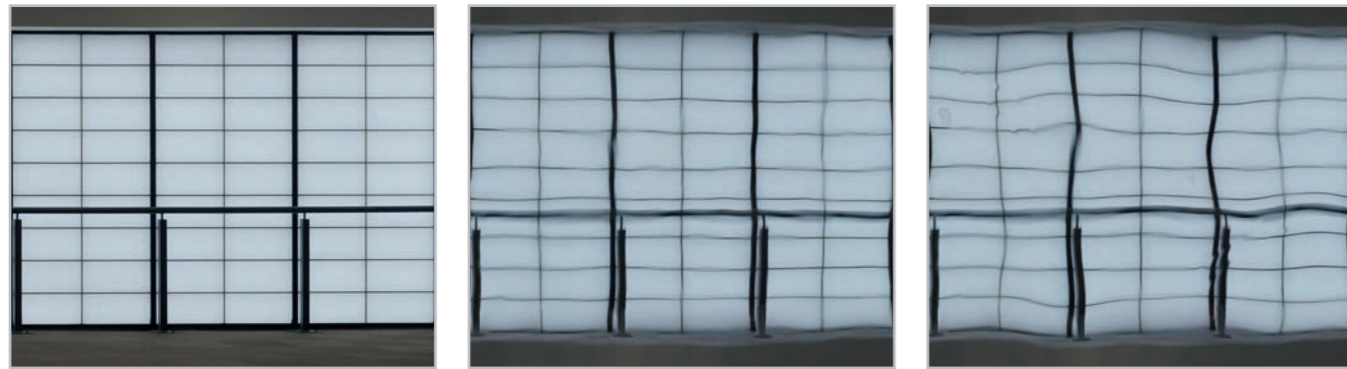

Float Glass

Machine Drawn

Hand Drawn



Decorative glass

We can supply coloured, leaded and stained glass finishes and accurately replicate designs.

Acoustic glass

For single glazing and historic narrow cavity glazing units there are a wide range of acoustic glass configurations that allow us to achieve excellent acoustic reduction.

Thermal laminates

We can apply different glass coatings to reduce the U-value of the glazing unit.

Obscure glass

We offer a large selection of obscure glass patterns, each of which have a privacy level rating based upon the degree of obscurity (with privacy level 5 being the highest).

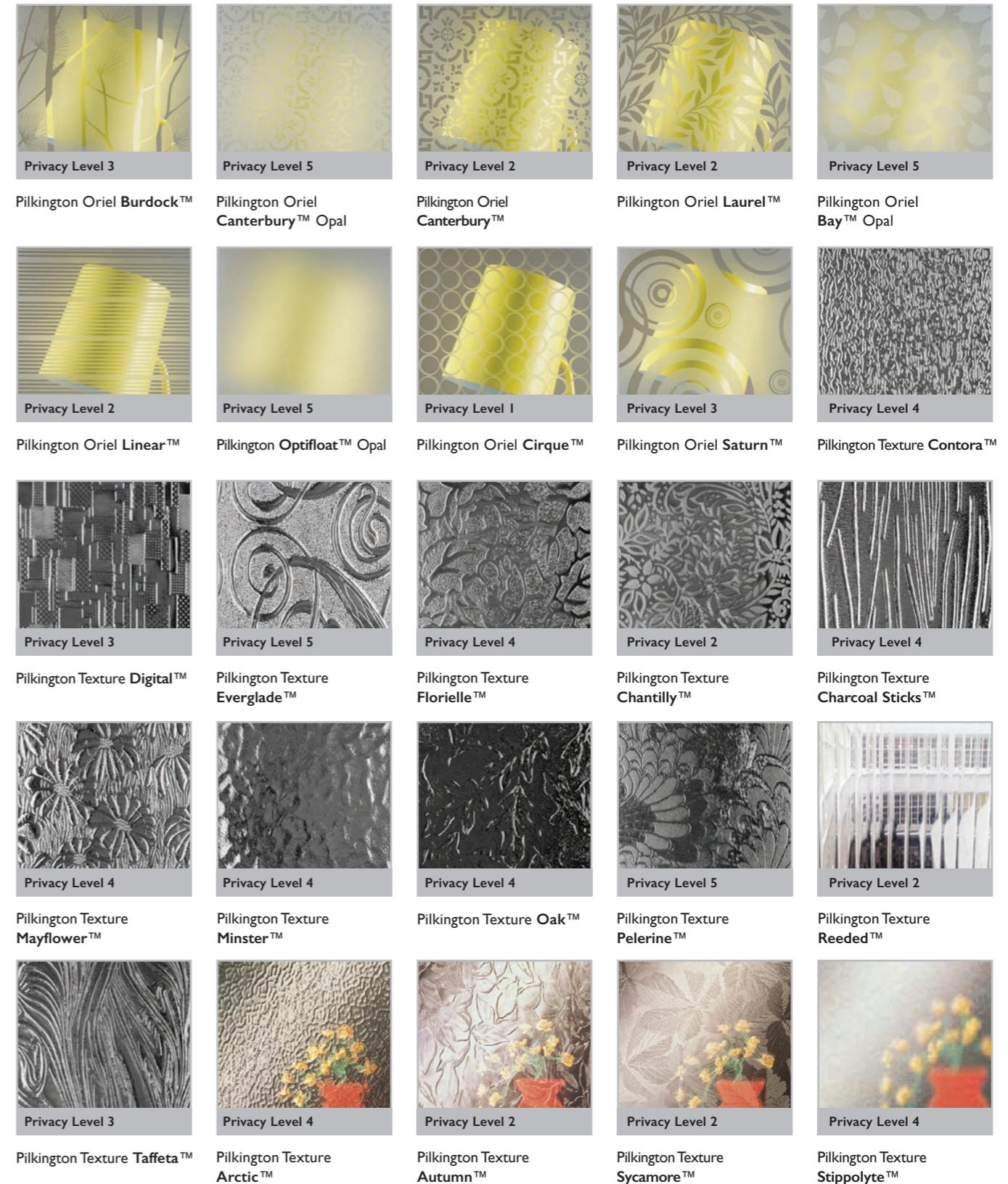

Timber Options

All of our timber is sustainably sourced and we can provide full FSC® chain of custody for our windows and doors upon request.

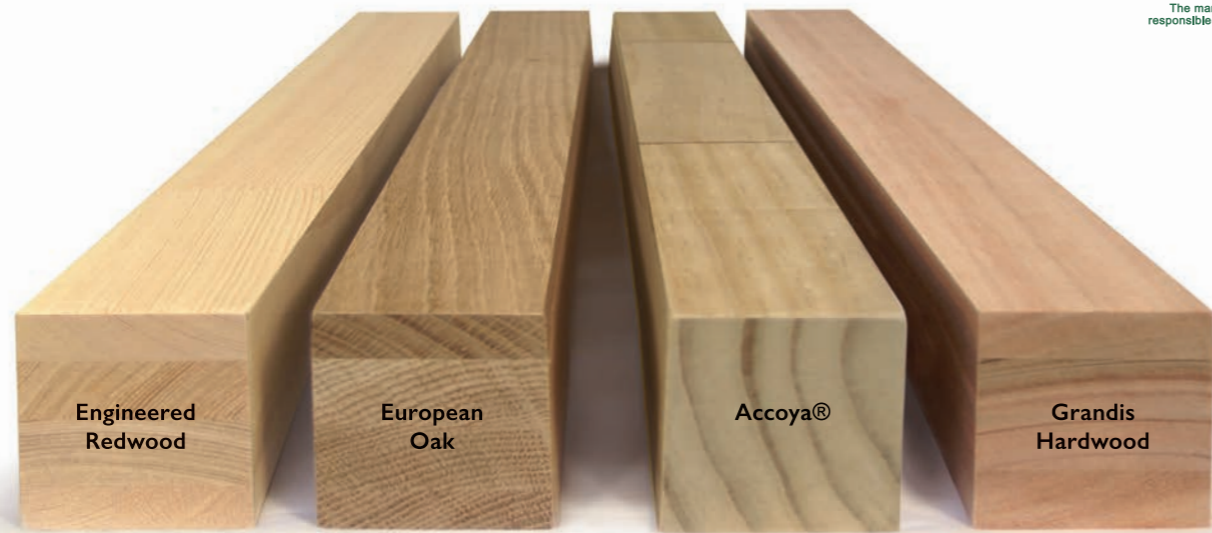

Engineered Redwood

Engineered Redwood is an excellent timber species for products requiring a paint finish because the reduced moisture uptake and increased stability of the timber produces a substrate which enhances the coating's life span. Being free of knots and imperfections not only enhances the aesthetic effect but also prevents the risk of resin exudation damaging the coating.

European Oak

European Oak is a very strong, durable hardwood that benefits from an attractive grain and colour. In the past, high quality windows and doors have been made from European Oak due to its durability. However, it has a tendency to move which can cause failure of the coating system and the glazing units. To overcome these problems we use knot free laminated European Oak which provides a greater amount of stability.

Accoya®

Accoya® has earned the highest durability rating of any timber, surviving for 25 years when submerged, uncoated, in fresh water. It is our timber of choice in the manufacture of external profiles because it provides a durable, stable base for our advanced paint system, promoting a long lasting, low maintenance finished product. We recommend Accoya® for coastal areas.

Grandis Hardwood

Grandis Hardwood provides a stable and durable substrate and is supplied as a three ply laminated material for extra stability. With its clear faced attractive grain pattern we manufacture all doors from Grandis as standard. We also recommend that Grandis is used to manufacture those products that require a stain finish.

Paint and Stain Colours

The type of coating and how it is applied significantly contributes to the longevity of any timber window or door. We have spent years researching the application of timber coatings, so that our advanced system provides maximum protection to the timber, while allowing it to breathe and let its natural beauty show through.

We offer the following standard paint and stain colours. If the colour you require is not included in the options below, then we can match to a physical sample or to an existing RAL, Natural Colour System or British Standard colour reference.



Paint colours*

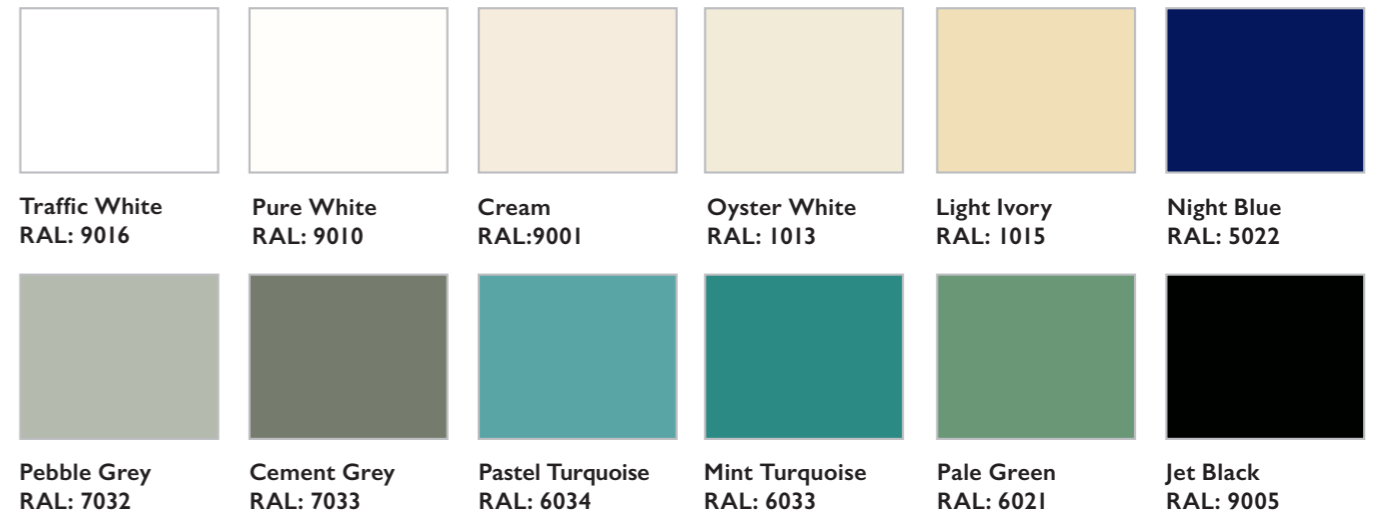

Stain colours

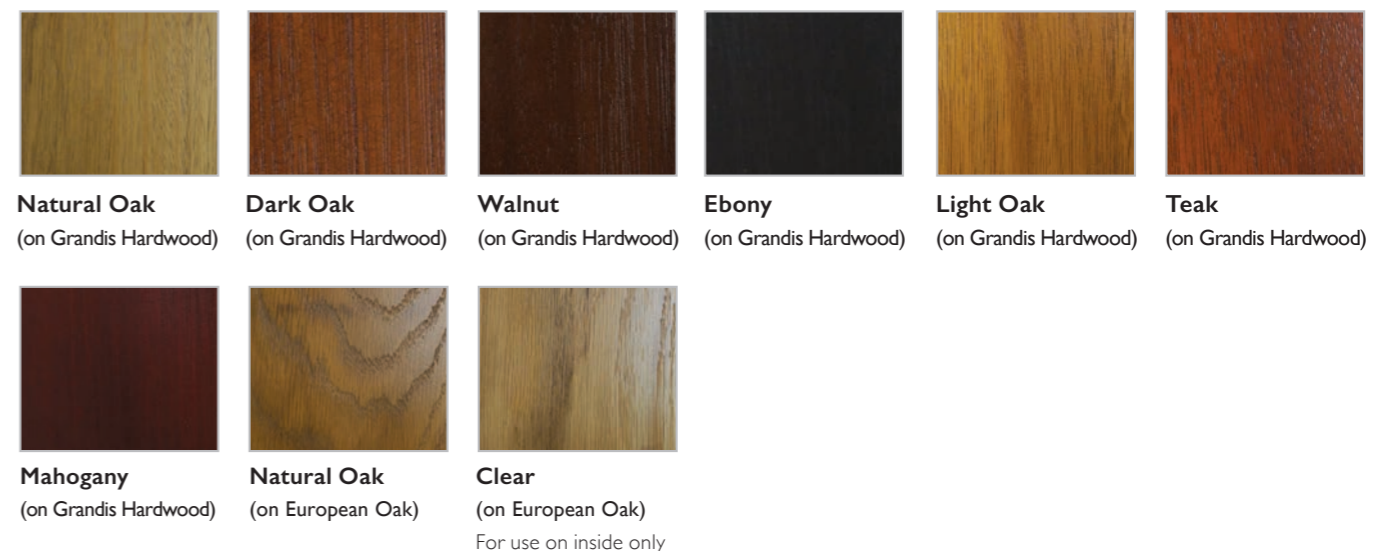

*Due to print variations these colours may vary, please contact us for a physical paint sample

Our Approach

Our approach is to devise a practical solution to a need, rather than shoe-horn an existing product into a unique design requirement. If you feel that the Historic Range does not fit your project requirements then maybe our Traditional or Contemporary timber windows and doors might be more suitable.

As we manufacture all of our windows and doors here in the UK, you are very welcome to visit our factory and see the products for yourself. Alternatively visit www.georgebarnsdale.co.uk to view our Traditional and Contemporary Ranges.



Traditional Range

Expertly designed for renovation and traditional new build projects, our Traditional Range combines period styling with exceptional performance without compromise.



Contemporary Range

Offering simple, clean, modern designs our Contemporary Range features large panes of efficient triple-glazing or acoustic double-glazing as standard.

For more information please call 01264 359355
email sales@kjmgroun.co.uk or visit
www.kjmgroun.co.uk

